

DADES:

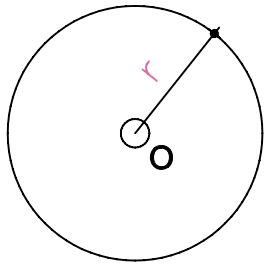

DONADES UNA CIRCUMFERÈNCIA I UNA RECTA AMB UN PUNT DE TANGÈNCIA.

TROBAR UNA CIRCUMFERÈNCIA DE RADI CONEGUT, TANGENT A LES DUES.

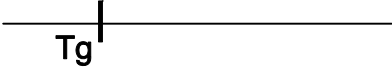

1.

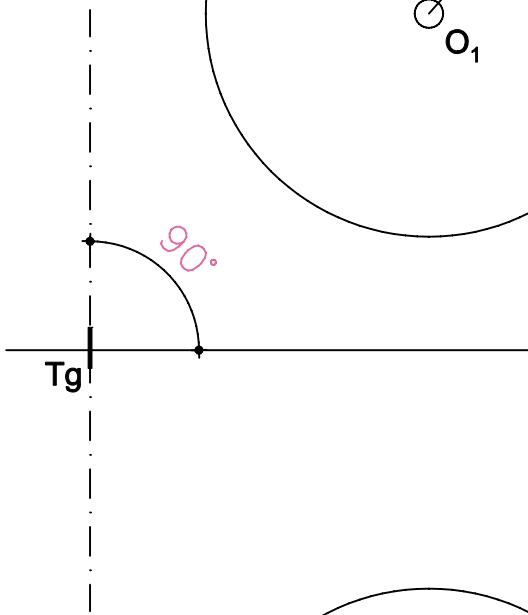
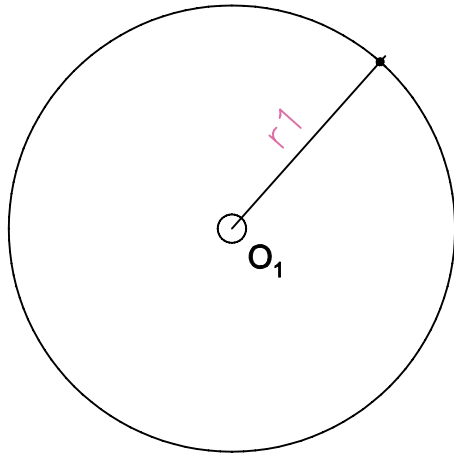

2.

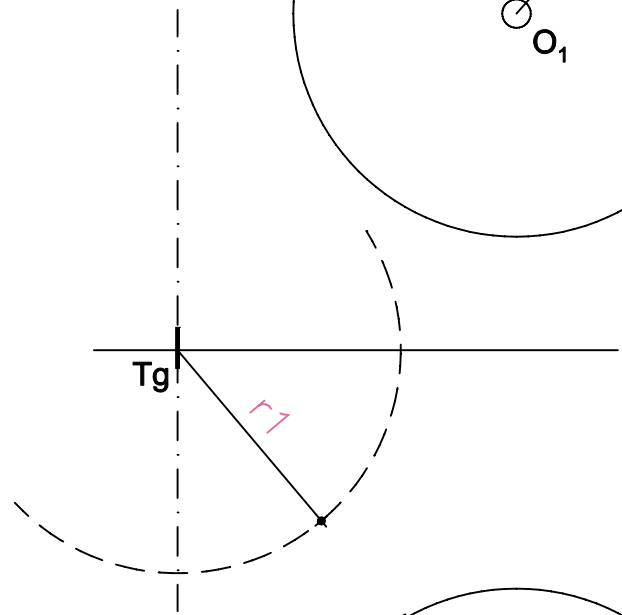
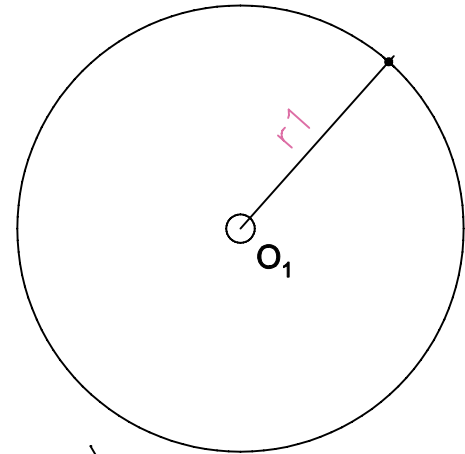

3.

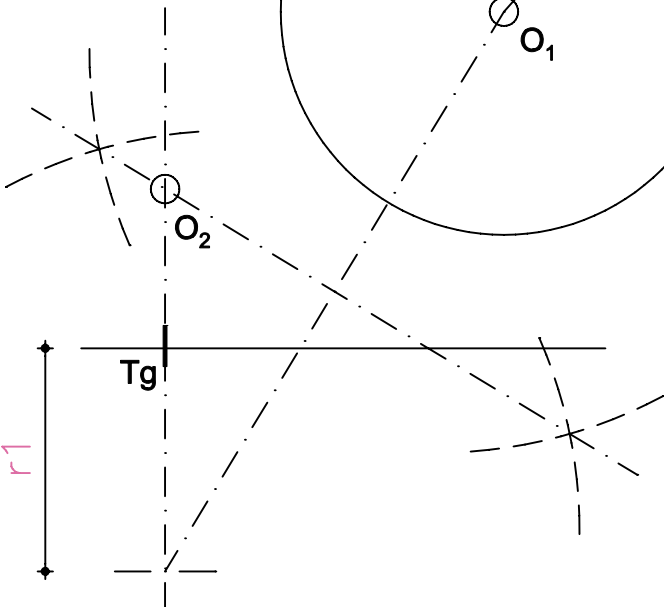
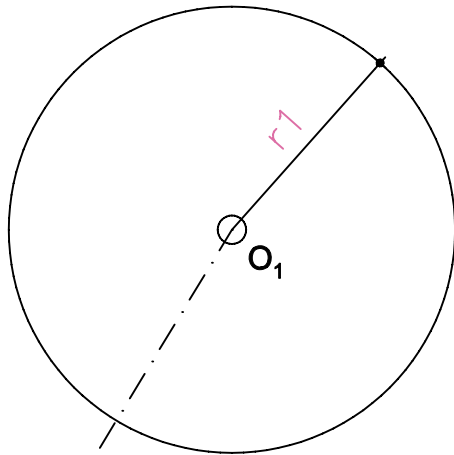

4.

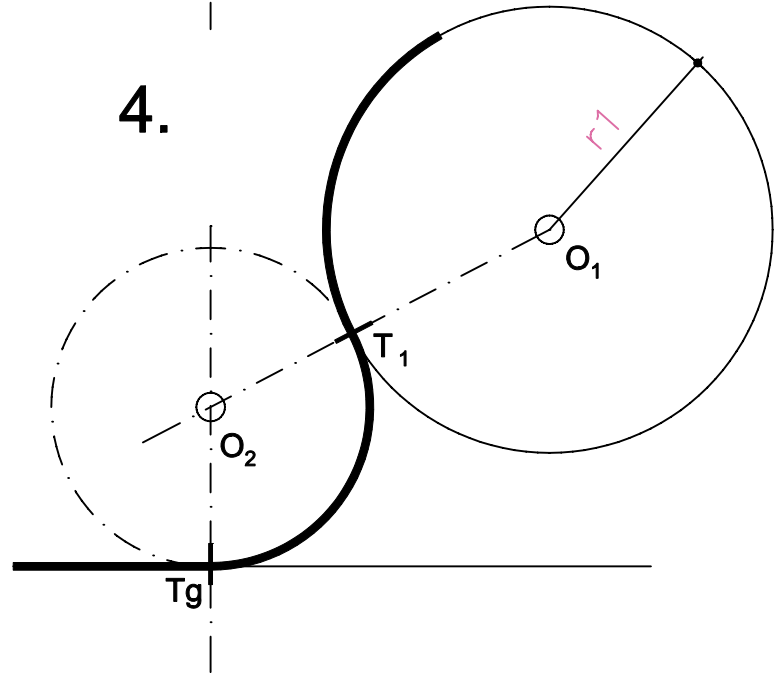

DADES:

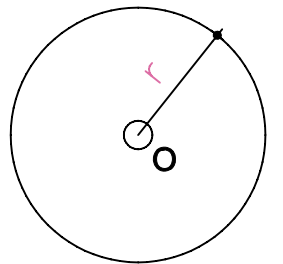

DONADES UNA CIRCUMFERÈNCIA I UNA RECTA AMB UN PUNT DE TANGÈNCIA.

TROBAR UNA CIRCUMFERÈNCIA EXTERIOR DE RADI CONEGUT, TANGENT A LES DUES.

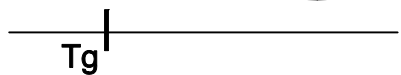

1.

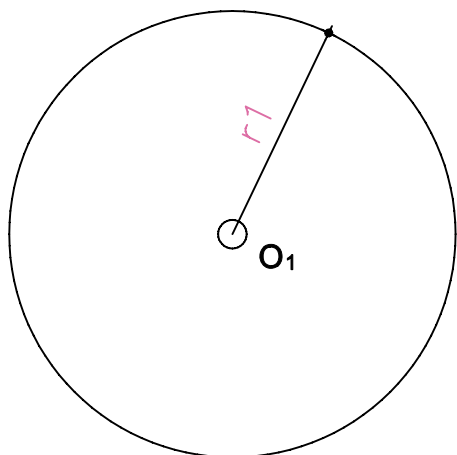

2.

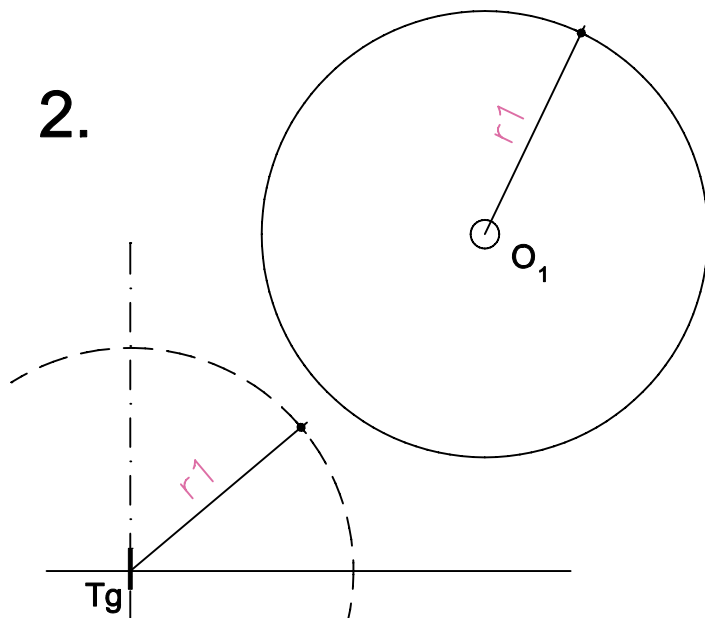

3.

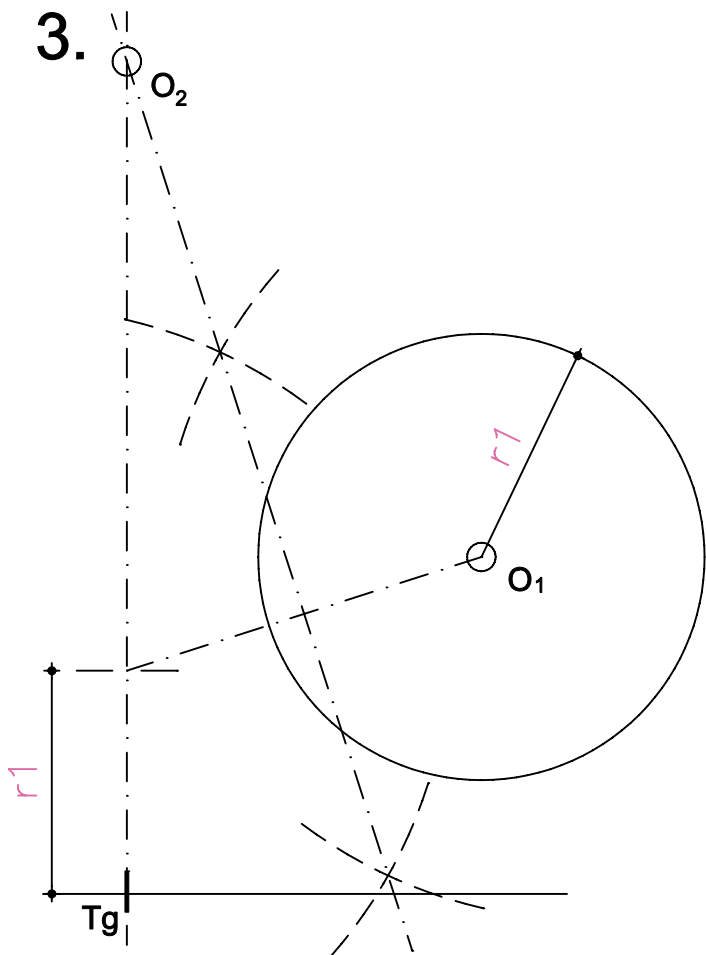

4.

